

# FTP-V WiFi, FTU-V WiFi, FTW-V WiFi

- |                           |   |
|---------------------------|---|
| (AT) BEDIENUNGSANLEITUNG  | (IT) ISTRUZIONI D'USO                       |
| (CH) BEDIENUNGSANLEITUNG  | (LV) LIETOŠANAS INSTRUKCIJA                 |
| (CZ) NÁVOD K POUŽÍVÁNÍ    | (LT) STOGO LANGO EKSPLOATACIJOS INSTRUKCIJA |
| (DE) BEDIENUNGSANLEITUNG  | (NO) BRUKSANVISNING FOR FAKRO TAKVINDU      |
| (DK) MONTERINGSVEJLEDNING | (NL) GEBRUIKSAANWIJZING                     |
| (ES) MANUAL DEL USUARIO   | (PL) INSTRUKCJA UŻYTKOWANIA                 |
| (FR) MANUEL D'UTILISATION | (RO) INSTRUCȚIUNI DE UTILIZARE              |
| (FI) KÄYTTÄJÄN OHJEET     | (RU) ИНСТРУКЦИЯ ПО ЭКСПЛУАТАЦИИ             |
| (GB) USER MANUAL          | (SE) BRUKSANVISNING                         |
| (GR) ΕΓΧΕΙΡΙΔΙΟ ΧΡΗΣΤΗ    | (SK) NÁVOD K OBSLUHE                        |
| (HR) UPUTE ZA KORIŠTENJE  | (SI) NAVODILA ZA UPORABO                    |
| (HU) HASZNÁLATI ÚTMUTATÓ  | (UA) ІНСТРУКЦІЯ ПО ЕКСПЛУАТАЦІЇ             |

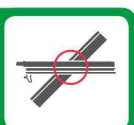

FTP-V  
WiFi  
FTU-V  
WiFi  
FTW-V  
WiFi

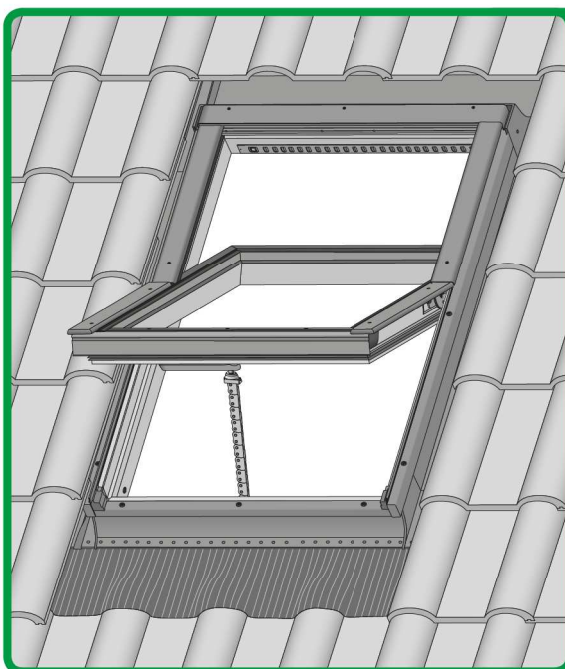
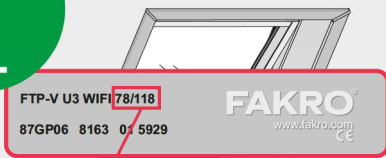

ARS  
ARP  
ARF  
AJP  
APS  
APF



AMZ  
ARZ



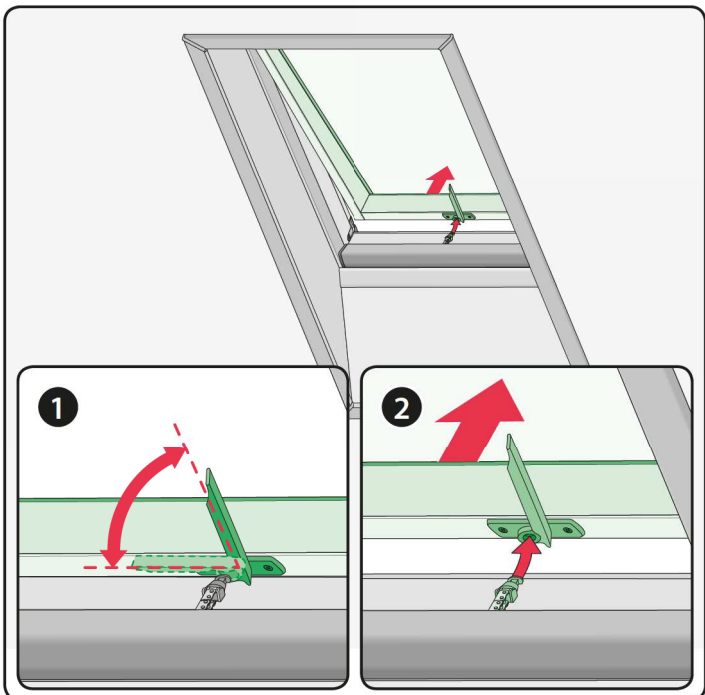
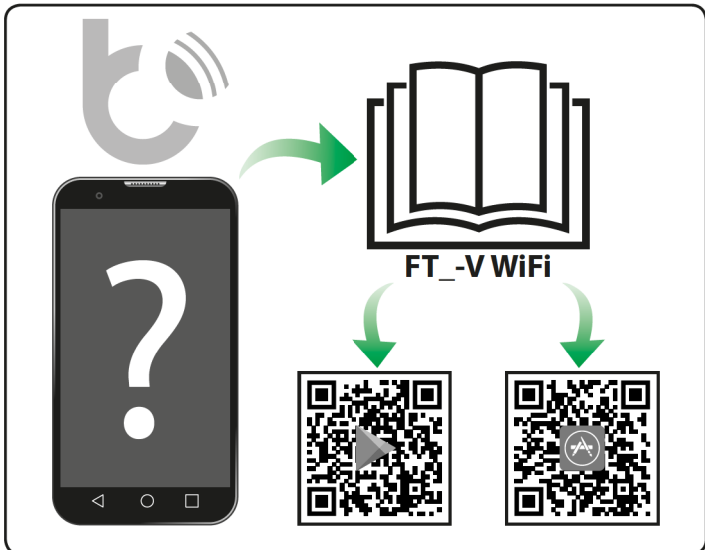

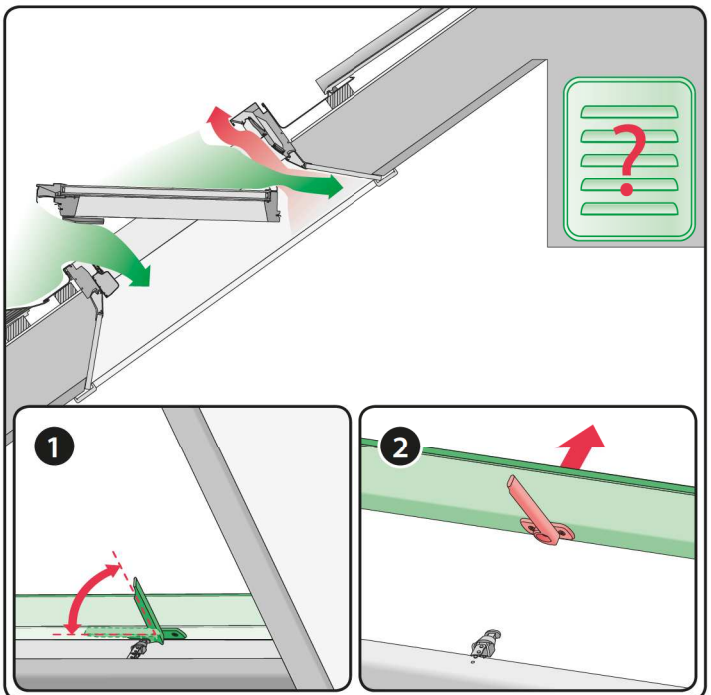
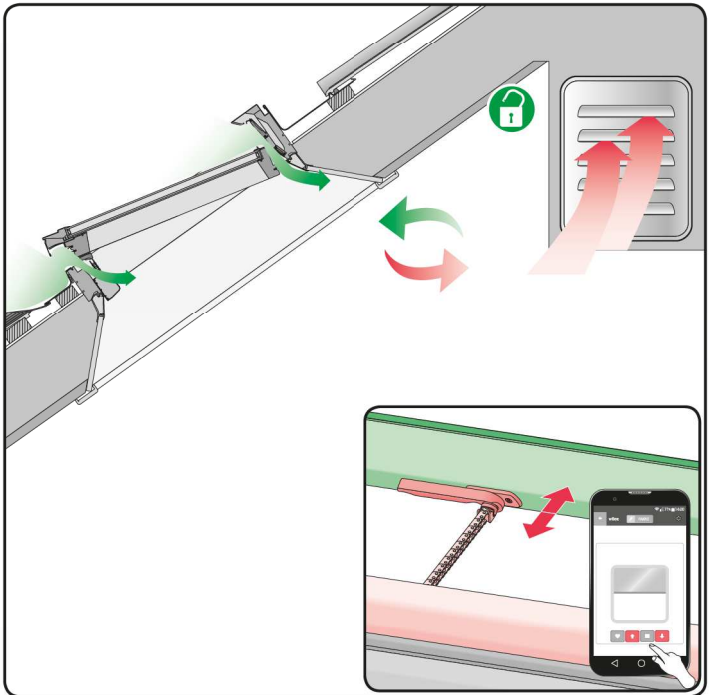
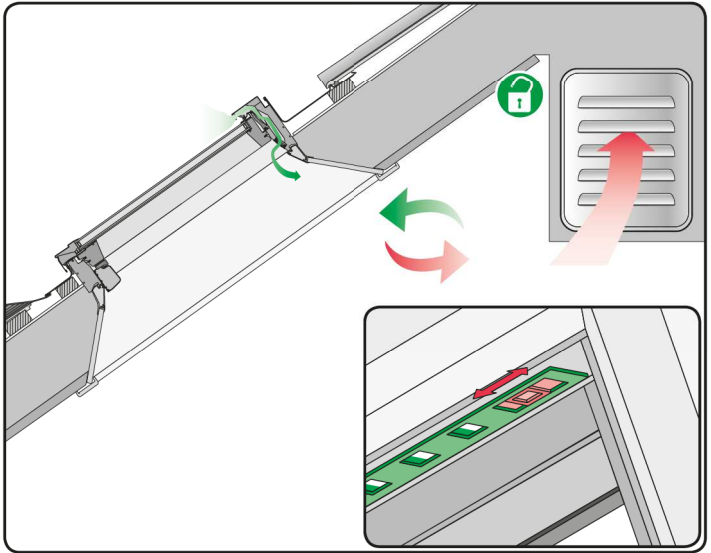

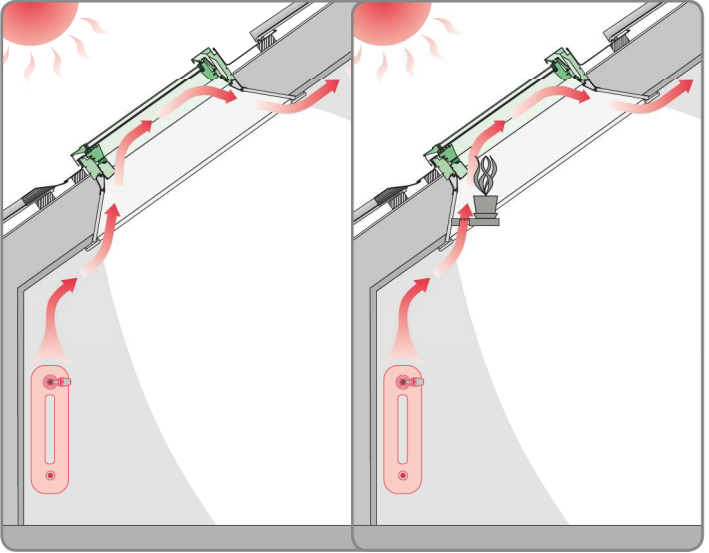

V40P

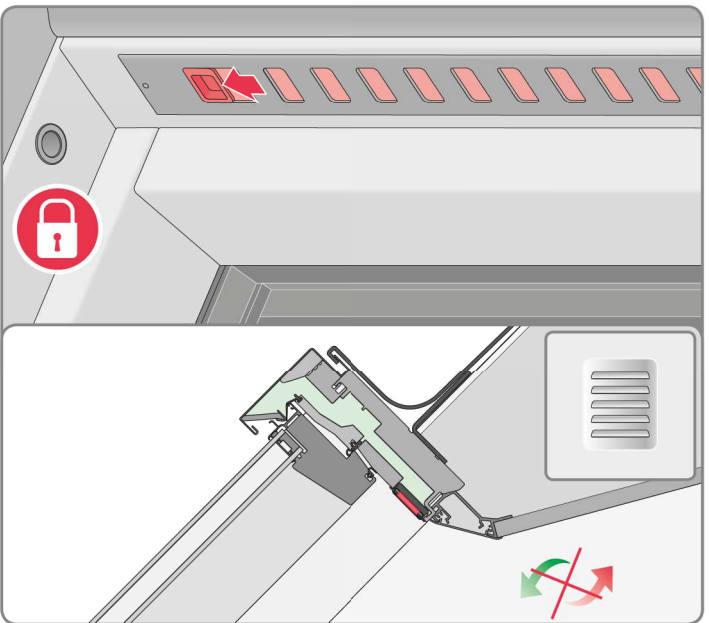
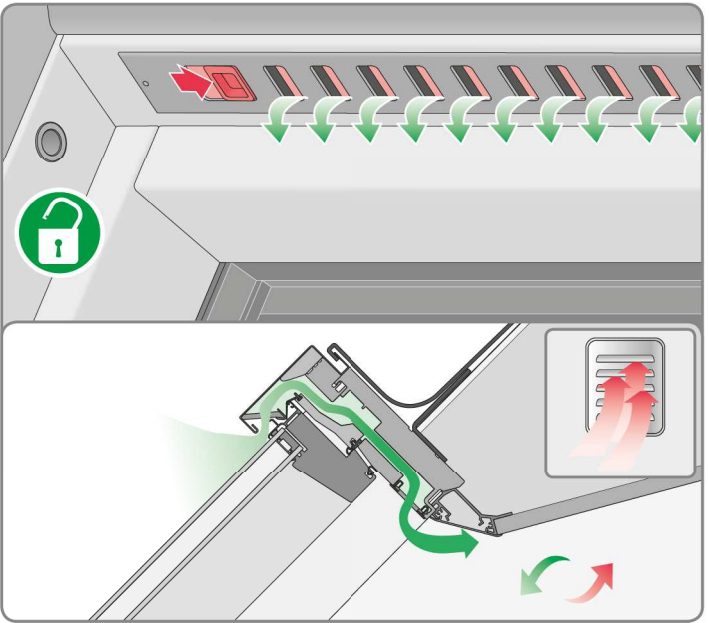

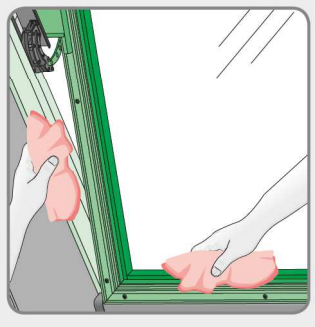
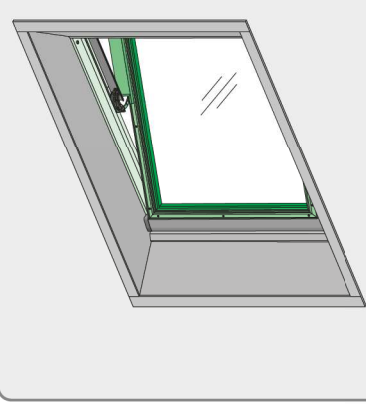
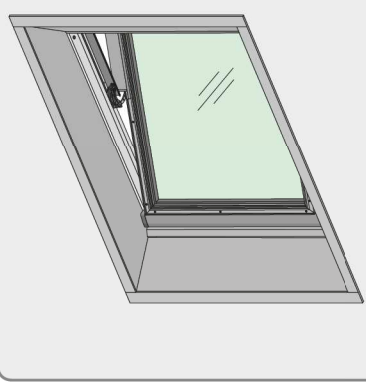
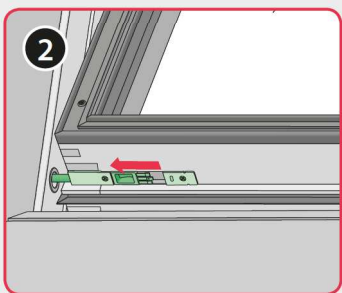
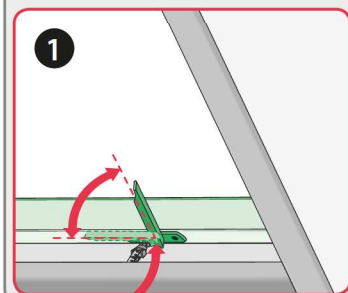
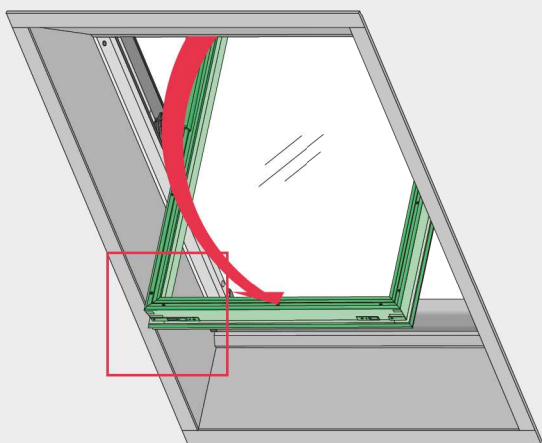

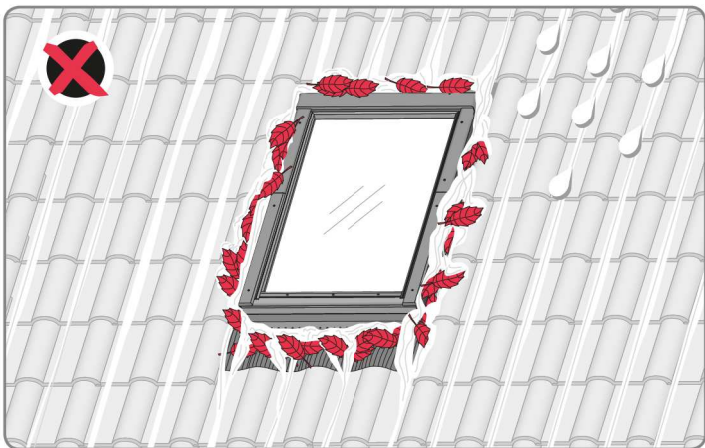
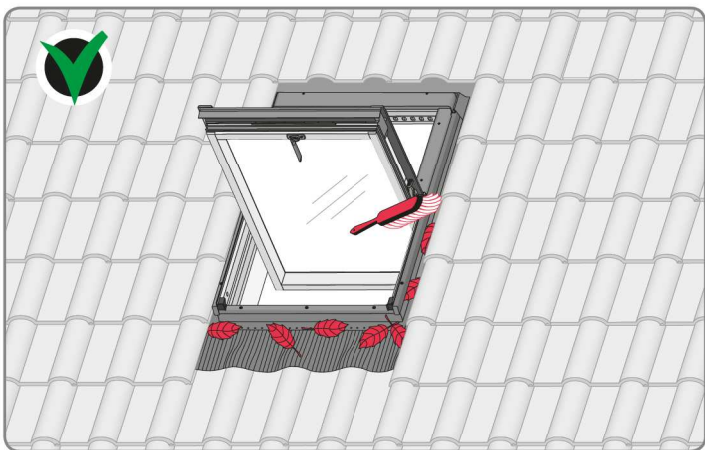
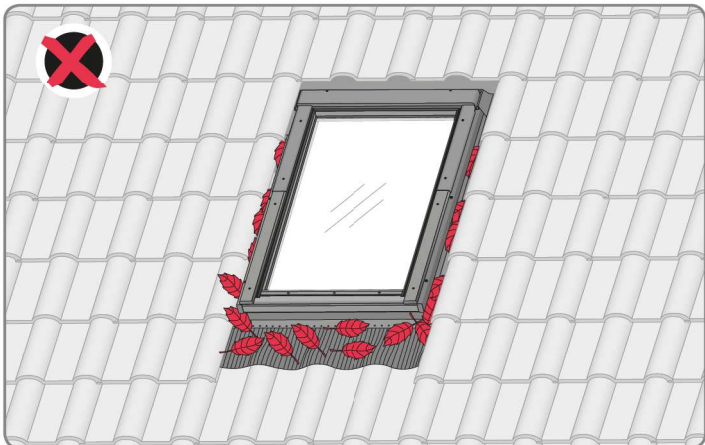

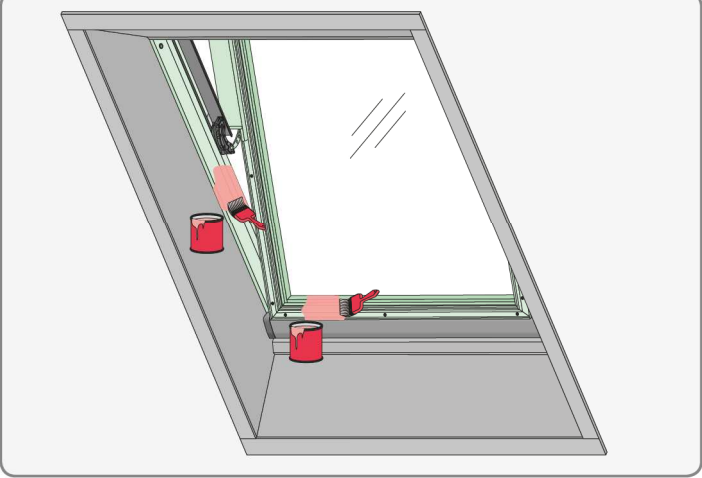
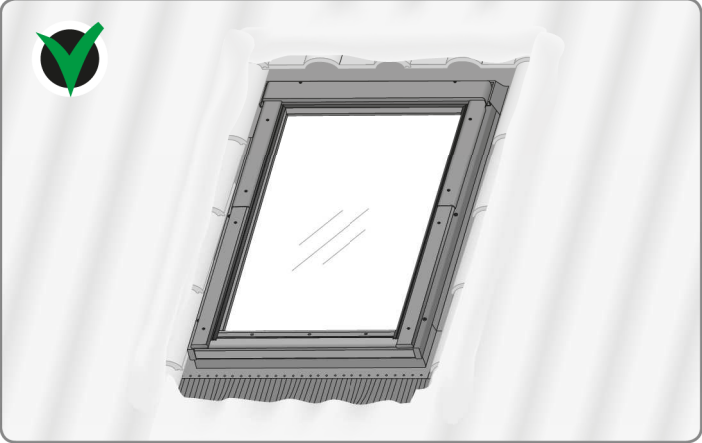

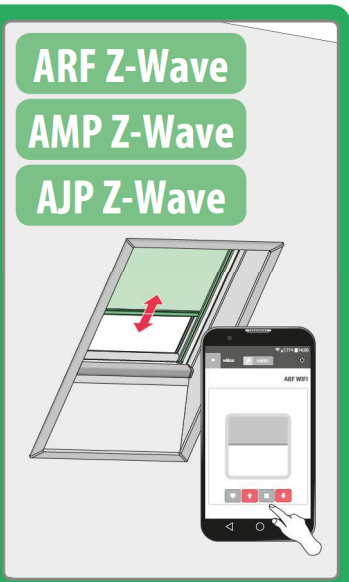
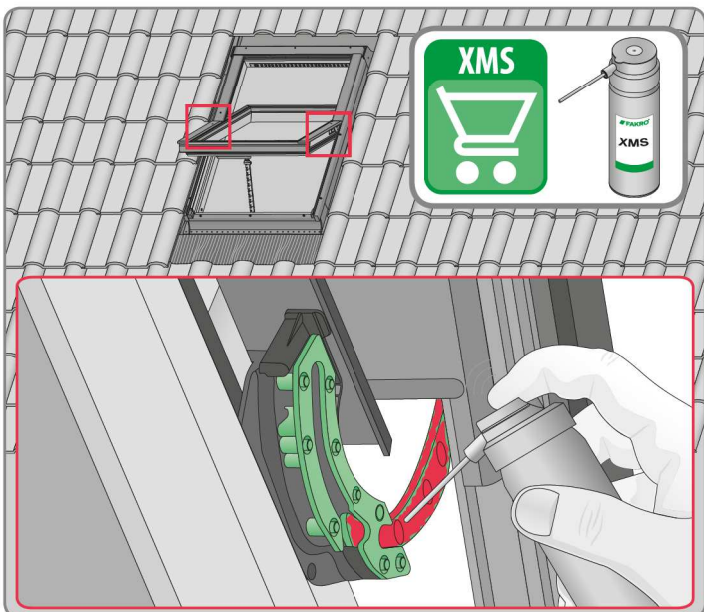

**CE**  
EN 14351-1:2006+A2:2016

**DECLARAȚIA ZA EKSPLOATAȚIONNI POCAZATELI - PROHLÁSENÍ O VLASTNOSTECH - LEISTUNGSERKLÄRUNG - YDEEVNEDECLARATION - TOIMIVUDECLARATSIIOON - DECLARACION DE PRESTACIONES - DECLARATION DES PERFORMANCES - DECLARATION OF PERFORMANCE - IZJAVA O SVOJSTVIMA - TELJESITMÉNYNYILATKOZAT - DICHIARAȚIUNE DI PRESTAZIONE - EKSPLOATACINIŲ SAVYBIŲ DEKLARACIJA - EKSPLUATACIJAS ĪPAŠĪBU DEKLARĀCIJA - PRESTATIEVERKLARING - YTELSEERKLJERING - DEKLARACJA WŁAŚCIWOŚCI UŻYTKOWYCH - DECLARAÇÃO DE DESEMPENHO - DECLARAȚIE DE PERFORMANȚĂ - PRESTANDADECLARATION - IZJAVA O LASTNOSTIH - VYHLÁSENIE O PARAMETROCH**

<http://www.fakro.com/ce-declarations/search>

- |   |   |
|---|---|
| <p><b>BG</b> Производител и Продавач не носят отговорност за неспазване на съответните закони, строителни норми и изисквания за безопасност от потребителя на продукта, архитекта, монтажника или собственика на сградата.</p> <p><b>CZ</b> Vyrobcé ani prodejce nenesou žádnou odpovědnost za nedodržení příslušných platných zákonů, stavebních předpisů a bezpečnostních požadavků uživatelem výrobku, architektem, montážníkem nebo vlastníkem budovy.</p> <p><b>DE</b> Hersteller und Verkäufer übernehmen keine Haftung für Nichtbeachtung entsprechender Rechts- und Bauvorschriften sowie Sicherheitsanforderungen seitens Produktbenutzers, Architekten, Monteure oder Gebäudebesitzers.</p> <p><b>ES</b> El fabricante y el vendedor no tienen ninguna responsabilidad por el incumplimiento de la ley vigente, normas de construcción y exigencias de seguridad por parte del usuario del producto, arquitecto, instalador o el propietario del edificio.</p> <p><b>FR</b> Le fabricant et le revendeur ne prend aucune responsabilité de ne pas respecter les lois applicables, les règlements sur les bâtiments et les exigences de sécurité par l'utilisateur du produit, l'architecte, l'installateur ou le propriétaire du bâtiment.</p> <p><b>GB</b> Manufacturer and Seller shall bear no liability for failure to comply with the applicable laws, building codes and safety requirements by the user of the product, architect, fitter or owner of the building.</p> <p><b>HU</b> A Gyártó és a Forgalmazó nem vállal semmiféle felelősséget a vonatkozó törvényi, építési és biztonsági előírások termékfelhasználó, építész, beépítőmester vagy épülettulajdonos általi nem tartásáért.</p> | <p><b>IT</b> Il Produttore e il Rivenditore non potranno essere ritenuti responsabili per il mancato rispetto, da parte dell'utente del prodotto, del progettista, dell'installatore o del proprietario dell'edificio, delle leggi vigenti, nonché dei regolamenti edilizi e di quelli relativi alla sicurezza.</p> <p><b>NL</b> De fabrikant en verkoper zijn niet aansprakelijk voor gevolgen bij het niet opvolgen van toepasselijke wetten, bouwbesluiten en veiligheidsvoorschriften door de gebruiker van het product, de architect, de installateur of de eigenaar van het gebouw.</p> <p><b>PL</b> Producent i Sprzedawca nie ponosi żadnej odpowiedzialności za nieprzestrzeganie stosownych przepisów prawa, przepisów budowlanych i wymogów bezpieczeństwa przez użytkownika produktu, architekta, montażystę lub właściciela budynku.</p> <p><b>PT</b> O fabricante e o vendedor não tem nenhuma responsabilidade pelo o não cumprimento da lei, códigos de construção e as exigências de segurança por parte do usuário do produto, arquiteto, instalador ou proprietário do edifício.</p> <p><b>RO</b> Nici producătorul, nici distribuitorul nu își vor asuma niciun fel de răspundere pentru nerespectarea legilor în vigoare, a legilor din domeniul construcțiilor sau a măsurilor de siguranță impuse utilizatorilor produsului, arhitecților, montajorilor sau proprietarilor clădirii.</p> <p><b>RU</b> В случае несоблюдения архитектором, монтажником или владельцем здания строительных правил и норм безопасности ответственность с производителя и продавца снимается.</p> <p><b>SK</b> Vyrobcia a predajca nenesú žiadnu zodpovednosť za nedodržanie príslušných ustanovení zákona, stavebných predpisov a bezpečnostných požiadaviek užívateľom výrobku, architektom, montérom alebo majiteľom objektu.</p> |
|---|---|